



ALPLER

AGRICULTURAL MACHINERY



PRODUCT CATALOGUE



ABOUT US



Alpler Agricultural Machinery, is the largest agricultural machinery producer in Turkey, and one of the few leading companies in the world in the agricultural equipment sector, is operating with more than 450 employees in its facilities established on a total area of 150,000 m² in the city of Aydin.

Thanks to its skilled staff and modern technology, it has the most advanced manufacturing and the widest after-sales service network in its sector in Turkey.

Alpler Agricultural Machinery is the only factory in Turkey that operates in mass production conditions, and plays an important role in the country's development with its exports to 90 countries on 5 continents.

Founded in 1926, Alpler Agricultural Machinery is managed by the third generation of the family as of today and continues its development by closely following the developing world technologies and market conditions.

The company has CE certificate, which is the production certificate in compliance with the technical requirements of the European Union, and has been operating under the ISO 9001 Quality Management System since 2004.

Alpler Agricultural Machinery, being a popular and sought-after brand in the domestic and international markets, has adopted as the company policy to offer Turkish and foreign farmers the strongest, the safest, the most balanced and the most suitable agricultural equipment that can adapt to any brand of tractors in all types of terrain conditions.





Thanks to the dynamic marketing understanding, more than 1,000,000 agricultural implements that the company has produced since its establishment serve successfully in the agricultural lands at home and abroad.



SEMI-MOUNTED REVERSIBLE PLOUGH

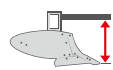

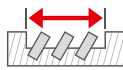
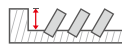
- ▶ Economical solution for big lands and high HP tractors.
- ▶ Different adjustment options for the best tractor-plough adaptation.
- ▶ Thanks to the hydraulic adjustable swinging depth & transport wheel, ploughing at a constant depth and safe transportation.

MODEL	 NUMBER OF FURROWS (PIECES)	 CLEARANCE (CM)	 DISTANCE BETWEEN BEAMS (CM)	 WORKING WIDTH (CM)	 WORKING DEPTH (CM)	 WEIGHT (KG)	 POWER REQUIREMENT (HP)
YADP 06	6	80	90	210-240-270	40	3150	170-190
YADP 07	7	80	90	245-280-315	40	3460	180-220
YADP 08	8	80	90	280-320-360	40	3760	210-250

* It is possible to change the technical details above in line with customer needs.
 * There may be changes in product technical details and standard accessories, product images are for general promotion.
 * The specified required horsepowers may differ up to $\pm 20\%$ depending on the soil structure and technical characteristics of the tractors (two-wheel drive, etc.).
 * The specified weights may differ up to $\pm 15\%$ depending on optional parts.

SEMI-MOUNTED REVERSIBLE PLOUGH



- ▶ Reversible ploughs are easy to pull, light to lift and consume as little fuel as possible. Wear parts are long lasting.
- ▶ The innovations introduced in the ploughs of Alpler and the design of the wear parts allow quick replacement and adjustment or adaptation to any type of terrain and field conditions.

OPTIONAL PARTS

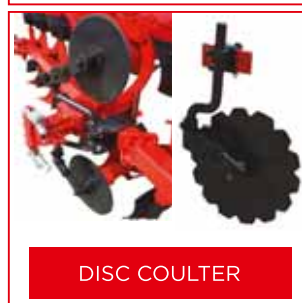

REVERSIBLE PLOUGH



- ▶ Time savings and reduced fuel consumption.
- ▶ Ploughing without disturbing the field leveling.
- ▶ Three positions mechanically (standard) or infinitely variable hydraulic working width adjustment from tractor seat (optional).
- ▶ Flanged frame to add an extension, if required.
- ▶ Possibility to transport by placing easily in transport position.
- ▶ Different adjustment mechanisms for the best tractor-plough adaptation.
- ▶ Different chassis options manufactured from special alloyed seamless profile.
- ▶ Standardly supplied deflector and shear bolt safety.



▶ *CHASSIS OPTIONS*

- ▶ 100x100 mm Light Model (**DPH**)
- ▶ 120x120 mm Standard (**DP**)
- ▶ 140x140 mm Heavy Model (**DPA**)

REVERSIBLE PLOUGH

OPTIONAL PARTS

- ▶ Trash boards
- ▶ Shares, mouldboards with reversible points
- ▶ Skimmer
- ▶ Slatted body
- ▶ Wing coulter
- ▶ Disc coulter
- ▶ Bar point body

Metal Depth Wheel

- ▶ Optional on 2 furrow ploughs
- ▶ Standard on 3 furrow ploughs

Swinging Depth & Transport Wheel

- ▶ Standard on 4 and 5 furrow ploughs

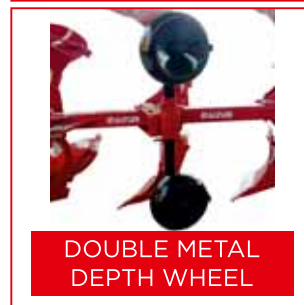
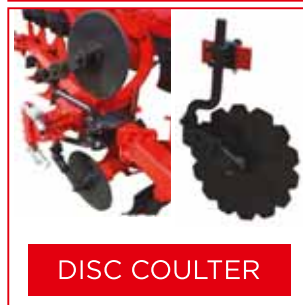
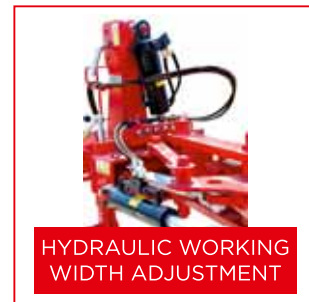

* MODEL	CLEARANCE (CM)	DISTANCE BETWEEN BEAMS (CM)	WORKING WIDTH (CM)	WORKING DEPTH (CM)	WEIGHT (KG)				POWER REQUIREMENT (HP)			
					2	3	4	5	2	3	4	5
DPH12	80	90	25-30-35	27,5-32,5	665	920	1150	-	50-70	75-95	90-110	-
DP12	80	90	25-30-35	27,5-32,5	705	985	1245	1470	55-75	85-105	95-115	125-145
DP14	80	90	30-35-40	30-35	705	985	1245	1470	55-75	85-105	95-115	125-145
DP16	80	90	35-40-45	30-35	705	985	1245	1470	60-80	90-110	100-120	130-150
DP18	80	90	40-45-50	30-35	705	985	1245	1470	60-80	90-110	100-120	130-150
DPA14	80	90	30-35-40	30-35	-	1205	1435	1695	-	95-115	130-150	150-170
DPA16	80	90	35-40-45	30-35	-	1205	1435	1695	-	100-120	135-155	155-175
DPA18	80	90	40-45-50	30-35	-	1205	1435	1695	-	100-120	135-155	155-175

- * When placing an order, add the number of furrows you need to the end of model code.
- It is possible to change the technical details above in line with customer needs.
- There may be changes in product technical details and standard accessories, product images are for general promotion.
- The specified required horsepowers may differ up to $\pm 20\%$ depending on the soil structure and technical characteristics of the tractors (two-wheel drive, etc.).
- The specified weights may differ up to $\pm 15\%$ depending on optional parts.





REVERSIBLE PLOUGH WITH HYDRAULIC SAFETY

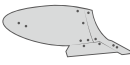
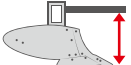

CHASSIS OPTIONS

120x120 mm Standard (**DPHE**)

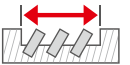
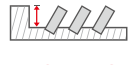
140x140 mm Heavy Model (**DPAHE**)

MODEL	 NUMBER OF FURROWS (PIECES)	 CLEARANCE (CM)	 DISTANCE BETWEEN BEAMS (CM)	 WORKING WIDTH (CM)	 WORKING DEPTH (CM)	 WEIGHT (KG)	 POWER REQUIREMENT (HP)
DPHE 30	3	80	90	35-40-45	30 - 40	1170	90-110
DPHE 40	4	80	90	35-40-45	30 - 40	1520	130-150
DPAHE 41	5	80	90	35-40-45	30 - 40	1980	150-170
DPAHE 50	5	80	90	35-40-45	30 - 40	2020	160-180

* It is possible to change the technical details above in line with customer needs.

* There may be changes in product technical details and standard accessories, product images are for general promotion.

* The specified required horsepowers may differ up to $\pm 20\%$ depending on the soil structure and technical characteristics of the tractors (two-wheel drive, etc.).

* The specified weights may differ up to $\pm 15\%$ depending on optional parts.

CONVENTIONAL PLOUGH

- ▶ Durable, problem-free, economical solution for all types of soil, appreciated by hundreds of thousands of farmers.
- ▶ Excellent plough-tractor balance.

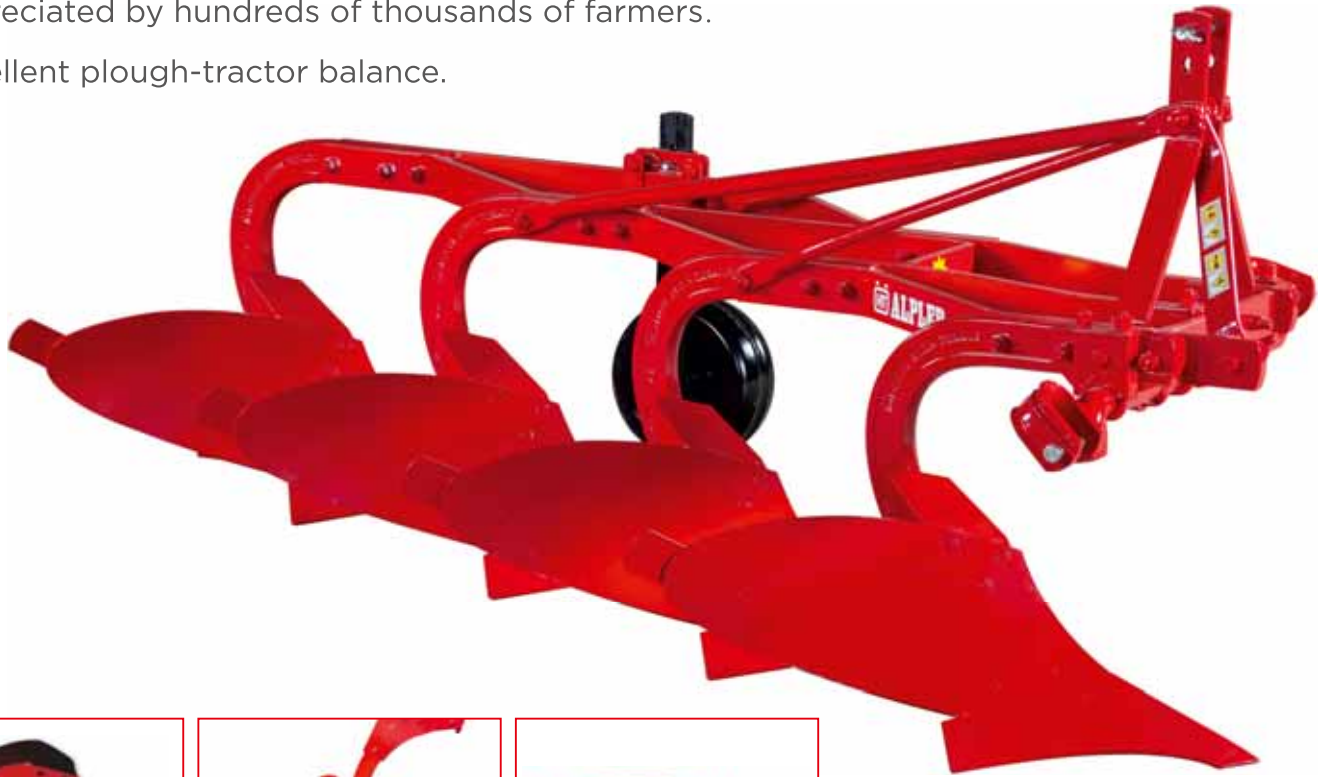

Metal Depth Wheel

- ▶ Optional on 1 - 2 and 3 furrow ploughs,
- ▶ Standard on 4 - 5 and 6 furrow ploughs.

* MODEL	CLEARANCE (CM)	DISTANCE BETWEEN BEAMS (CM)	WORKING WIDTH (CM)	WORKING DEPTH (CM)	WEIGHT (KG)						POWER REQUIREMENT (HP)					
					1	2	3	4	5	6	1	2	3	4	5	6
SP10	68	70	25,5	24	175	215	320	493	620	760	25-30	30-40	45-50	70-80	80-90	80-90
SP12	68	76	30	26	177	226	341	523	654	800	30-35	40-50	55-60	70-85	90-100	95-115
SP14	68	78	35	28	177	244	360	547	680	830	35-40	40-50	60-70	80-90	90-100	110-125
SP16	68	86	40	30	204	272	417	619	803	916	40-45	50-60	70-80	80-90	100-110	125-135
SP18	68	86	45	32	220	308	485	715	890	962	45-50	60-70	80-90	90-100	100-120	135-150

- * When placing an order, add the number of furrows you need to the end of model code.
- It is possible to change the technical details above in line with customer needs.
- There may be changes in product technical details and standard accessories, product images are for general promotion.
- The specified required horsepowers may differ up to $\pm 20\%$ depending on the soil structure and technical characteristics of the tractors (two-wheel drive, etc.).
- The specified weights may differ up to $\pm 15\%$ depending on optional parts.

PROFILE CHASSIS PLOUGH

- ▶ Three positions mechanically (standard) or infinitely variable hydraulic working width adjustment from tractor seat (optional)
- ▶ Flanged frame to add an extension, if required.
- ▶ Strong chassis manufactured from special alloyed seamless profile.
- ▶ Standardly supplied deflector and shear bolt safety.



CHASSIS OPTIONS

- 100x100 mm Light Model (**PSPH**)
- 120x120 mm Standard (**PSP**)

OPTIONAL PARTS

- ▶ Trash boards
- ▶ Shares, mouldboards with reversible points
- ▶ Skimmer
- ▶ Slatted body
- ▶ Wing coulter
- ▶ Disc coulter
- ▶ Bar point body



* MODEL	CLEARANCE (CM)	DISTANCE BETWEEN BEAMS (CM)	WORKING WIDTH (CM)	WORKING DEPTH (CM)	WEIGHT (KG)			POWER REQUIREMENT (HP)		
					3	4	5	3	4	5
PSPH14	78	102	30-35-40	30	500	575	730	45-55	60-75	80-90
PSP14	78	102	30-35-40	30	540	707	825	50-55	75-80	90-100
PSP16	78	102	35-40-45	35	550	710	860	70-80	75-80	100-110
PSP18	78	102	40-45-50	40	560	730	895	75-85	80-90	110-120

- * When placing an order, add the number of furrows you need to the end of model code.
- It is possible to change the technical details above in line with customer needs.
- There may be changes in product technical details and standard accessories, product images are for general promotion.
- The specified required horsepowers may differ up to ± 20% depending on the soil structure and technical characteristics of the tractors (two-wheel drive, etc.).
- The specified weights may differ up to ± 15% depending on optional parts.

PROFILE CHASSIS PLOUGH

- ▶ 6, 7 and 8 furrows PSP models equipped with heavy duty head stock as standard.
- ▶ Upon request On-Land version is also available (optional).



*MODEL	CLEARANCE (CM)	DISTANCE BETWEEN BEAMS (CM)	WORKING WIDTH (CM)	WORKING DEPTH (CM)	WEIGHT (KG)			POWER REQUIREMENT (HP)		
					6	7	8	6	7	8
PSP14	78	102	30-35-40	30	990	1125	1260	120-135	135-145	145-155
PSP16	78	102	35-40-45	35	1020	1127	1264	135-145	145-155	155-170
PSP18	78	102	40-45-50	40	1038	1128	1266	140-155	155-170	170-200
PSPA14	78	102	30-35-40	30	1070	1150	1294	135-145	165-180	180-210
PSPA16	78	102	35-40-45	35	1120	1190	1345	145-155	170-190	190-220
PSPA18	78	102	40-45-50	40	1150	1215	1356	150-160	180-200	200-230

* When placing an order, add the number of furrows you need to the end of model code.
 - It is possible to change the technical details above in line with customer needs.
 - There may be changes in product technical details and standard accessories, product images are for general promotion.
 - The specified required horsepowers may differ up to $\pm 20\%$ depending on the soil structure and technical characteristics of the tractors (two-wheel drive, etc.).
 - The specified weights may differ up to $\pm 15\%$ depending on optional parts.

CONVENTIONAL PLOUGH WITH BAR POINT



- ▶ Economical solution for stony, rooted and difficult soil conditions.
- ▶ Cost reduction with use of high resistant bar point compared to plain share.
- ▶ By pushing the bar point forward, getting “first day ploughing quality”.



Metal Depth Wheel

- ▶ Optional on 1 - 2 and 3 furrow ploughs,
- ▶ Standard on 4 - 5 and 6 furrow ploughs.

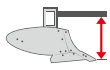
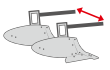
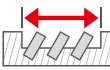
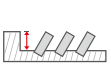





*MODEL	 CLEARANCE (CM)	 DISTANCE BETWEEN BEAMS (CM)	 WORKING WIDTH (CM)	 WORKING DEPTH (CM)	 WEIGHT (KG)					 POWER REQUIREMENT (HP)				
					1	2	3	4	5	1	2	3	4	5
					KP10	65	70	25,5	24	175	255	360	545	708
KP12	65	76	30	26	180	260	377	576	715	40-50	45-50	60-70	70-85	90-100
KP14	65	79	35	28	195	268	400	586	737	45-50	50-60	70-80	85-95	100-110
KP16	70	82	40	30	215	306	466	675	850	50-60	60-70	80-90	90-100	110-120

- * When placing an order, add the number of furrows you need to the end of model code.
- It is possible to change the technical details above in line with customer needs.
- There may be changes in product technical details and standard accessories, product images are for general promotion.
- The specified required horsepowers may differ up to ± 20% depending on the soil structure and technical characteristics of the tractors (two-wheel drive, etc.).
- The specified weights may differ up to ± 15% depending on optional parts.

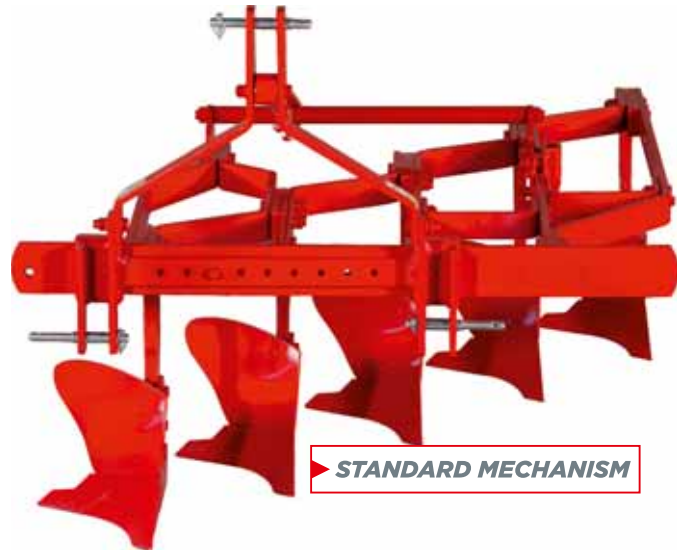
VINEYARD ORCHARD PLOUGH

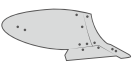
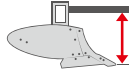
- ▶ Ability to easily approach tree trunks and fence edges with hydraulic (optional) or manual (standard) shifting mechanism.
- ▶ Permanent low working depth by metal wheel preventing the roots to be damaged.
- ▶ Plough made of heavy duty frame designed for stony and hard land conditions (BPA model).

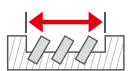
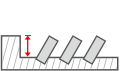

MODEL	 NUMBER OF FURROWS (PIECES)	 CLEARANCE (CM)	 DISTANCE BETWEEN BEAMS (CM)	 WORKING WIDTH (CM)	 WORKING DEPTH (CM)	 WEIGHT (KG)	 POWER REQUIREMENT (HP)
BP63	3	60	51	90	20	240	25-30
BP64	4	60	51	120	20	346	30-40
BP65	5	60	51	150	20	420	40-50
BP66	6	60	51	180	20	492	50-60

* It is possible to change the technical details above in line with customer needs.
 * There may be changes in product technical details and standard accessories, product images are for general promotion.
 * The specified required horsepowers may differ up to $\pm 20\%$ depending on the soil structure and technical characteristics of the tractors (two-wheel drive, etc.).
 * The specified weights may differ up to $\pm 15\%$ depending on optional parts.

AUTOMATIC PLOUGH WITH SPRING SAFETY



- ▶ Non-stop ploughing opportunity for stony, rooted and newly planted lands.
- ▶ Adjustable spring sensitivity, independent safety system for each body.
- ▶ Flanged frame to add an extension, if required.
- ▶ Optionally supplied hydraulic working width adjustment.









* MODEL	NUMBER OF FURROWS (PIECES)	CLEARANCE (CM)	DISTANCE BETWEEN BEAMS (CM)	WORKING WIDTH (CM)	WORKING DEPTH (CM)	WEIGHT (KG)	POWER REQUIREMENT (HP)
OPB 123	3	75	75	25-30-35	26	670	50-60
OPB 143	3	75	80	30-35-40	28	680	60-70
OPB 124	4	75	75	25-30-35	26	832	70-90
OPB 144	4	75	80	30-35-40	28	851	80-100
OPB 125	5	75	75	25-30-35	26	1005	90-110
OPB 145	5	75	80	30-35-40	28	1014	100-120

* When placing an order, add the number of furrows you need to the end of model code.
 - It is possible to change the technical details above in line with customer needs.
 - There may be changes in product technical details and standard accessories, product images are for general promotion.
 - The specified required horsepowers may differ up to ± 20% depending on the soil structure and technical characteristics of the tractors (two-wheel drive, etc.).
 - The specified weights may differ up to ± 15% depending on optional parts.

DIRECT FERTILIZER MACHINE

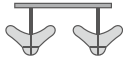
- ▶ Easy and simple row opening and fertilizing by single pass.
- ▶ Adjustable furrow width and dike height.
- ▶ Adjustable furrow spacing.
- ▶ Good clearance for safe working in high crop fields.
- ▶ Thanks to the sieve placed in the box for preventing any blockage in the fertilizer pipes.



MODEL	 NUMBER OF FURROWS (PIECES)	 CLEARANCE (CM)	 DISTANCE BETWEEN BEAMS (CM)	 WORKING WIDTH (CM)	 WEIGHT (KG)	 POWER REQUIREMENT (HP)
GM03	3	72	65-85	200	375	60-80
GM05	5	72	65-85	390	525	80-100

* It is possible to change the technical details above in line with customer needs.
 * There may be changes in product technical details and standard accessories, product images are for general promotion.
 * The specified required horsepowers may differ up to $\pm 20\%$ depending on the soil structure and technical characteristics of the tractors (two-wheel drive, etc.).
 * The specified weights may differ up to $\pm 15\%$ depending on optional parts.





MICRO PLOUGH

- ▶ Indispensable assistant of professional and hobby farmers.
- ▶ Light yet reinforced special material.
- ▶ Hitching system suitable for all types of garden tractors.

Metal Depth Wheel

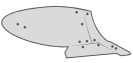
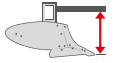
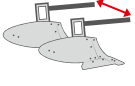
- ▶ Optional on 1 - 2 and 3 furrow ploughs,
- ▶ Standard on 4 and 5 furrow ploughs.

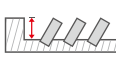

MODEL	 NUMBER OF FURROWS (PIECES)	 CLEARANCE (CM)	 DISTANCE BETWEEN BEAMS (CM)	 WORKING WIDTH (CM)	 WORKING DEPTH (CM)	 WEIGHT (KG)	 POWER REQUIREMENT (HP)
MP 041	1	47	43	23	16	50	10-15
MP 042	2	47	43	46	16	70	15-25
MP 043	3	47	43	69	16	103	25-30
MP 044	4	47	43	92	16	146	30-35
MP 045	5	47	43	115	16	207	35-45

* It is possible to change the technical details above in line with customer needs.

* There may be changes in product technical details and standard accessories, product images are for general promotion.

* The specified required horsepowers may differ up to $\pm 20\%$ depending on the soil structure and technical characteristics of the tractors (two-wheel drive, etc.).

* The specified weights may differ up to $\pm 15\%$ depending on optional parts.





MICRO GARDEN PLOUGH

- ▶ Indispensable assistant of professional and hobby farmers.
- ▶ Light yet reinforced special material.
- ▶ Hitching system suitable for all types of garden tractors.

Metal Depth Wheel

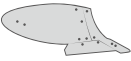
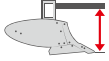
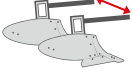
- ▶ Optional on 1 - 2 and 3 furrow ploughs,
- ▶ Standard on 4 and 5 furrow ploughs.

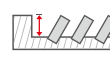





MODEL	 NUMBER OF FURROWS (PIECES)	 CLEARANCE (CM)	 DISTANCE BETWEEN BEAMS (CM)	 WORKING WIDTH (CM)	 WORKING DEPTH (CM)	 WEIGHT (KG)	 POWER REQUIREMENT (HP)
MPB 042	2	47	43	46	16	126	15-25
MPB 043	3	47	43	69	16	168	25-30
MPB 044	4	47	43	92	16	230	30-35
MPB 045	5	47	43	115	16	267	35-45

- It is possible to change the technical details above in line with customer needs.
- There may be changes in product technical details and standard accessories, product images are for general promotion.
- The specified required horsepowers may differ up to $\pm 20\%$ depending on the soil structure and technical characteristics of the tractors (two-wheel drive, etc.).
- The specified weights may differ up to $\pm 15\%$ depending on optional parts.

FURROW OPENER PLOUGH

- ▶ Reinforced body and specially designed frame.
- ▶ Easy and effortless adjustable furrow width.
- ▶ Ability to open deep and wide furrow in one pass.
- ▶ Indispensable assistant for irrigation and drainage works.

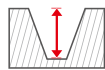

MODEL	 CLEARANCE (CM)	 FURROW WIDTH (CM)	 WORKING DEPTH (CM)	 WEIGHT (KG)	 POWER REQUIREMENT (HP)
KAP 12	73	60-90 (Adj.)	36	194	60-70
KAP 16	76	65-95 (Adj.)	40	196	70-80
KAP 20	80	70-100 (Adj.)	44	243	80-100

- It is possible to change the technical details above in line with customer needs.
 - There may be changes in product technical details and standard accessories, product images are for general promotion.
 - The specified required horsepowers may differ up to ± 20% depending on the soil structure and technical characteristics of the tractors (two-wheel drive, etc.).
 - The specified weights may differ up to ± 15% depending on optional parts.

DITCHER PLOUGH



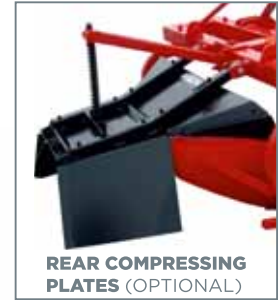





- ▶ Ditching and diking possibility with the same plough.
- ▶ Adjustable dike width.

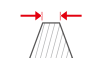

DIKING POSITION



DITCHING POSITION

MODELO	 CLEARANCE (CM)	 DISTANCE BETWEEN BEAMS (CM)	 DIKE WIDTH (CM)	 DIKE HEIGHT (CM)	 DITCH WIDTH (CM)	 DITCH DEPTH (CM)	 WEIGHT (KG)	 POWER REQUIREMENT (HP)
SKP 10 (ANGLE CHASSIS)	70	90-103-122-142-162	29-48-68-88	40	84	40	248	30-40
SKP 12 (ANGLE CHASSIS)	70	90-103-122-142-162	21-40-60-80	40	92	40	250	40-50
SKP 14 (ANGLE CHASSIS)	72	90-103-122-142-162	13-32-52-72	45	100	45	255	50-60
SKP 16 (ANGLE CHASSIS)	75	90-103-122-142-162	24-44-64	50	110	50	260	60-80
SKP 18 (SQUARE TUBE CHASSIS)	80	114-130-150-170	20-40-60-80-100	60	120	60	371	80-90
SKP 20 (SQUARE TUBE CHASSIS)	85	114-130-150-170	20-40-60-80-100	70	130	70	439	90-100

- It is possible to change the technical details above in line with customer needs.
- There may be changes in product technical details and standard accessories, product images are for general promotion.
- The specified required horsepowers may differ up to $\pm 20\%$ depending on the soil structure and technical characteristics of the tractors (two-wheel drive, etc.).
- The specified weights may differ up to $\pm 15\%$ depending on optional parts.

CHISEL PLOUGH

- ▶ Special alloyed cast steel legs with safety bolts designed to give the most suitable penetration angle for maximum efficiency.
- ▶ Possibility to work in different working widths thanks to adjustable leg spaces.
- ▶ High point savings with heat-treated double-sided share structure.
- ▶ Clearance option of 74 cm for the CPY model and 62 cm for the CP model.







CHISEL PLOUGH

CHASSIS OPTIONS

80x80 mm
Light Model (CPH)

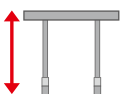
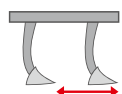
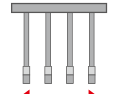
100x100 mm
Standard (CP-CPY)

120x120 mm
Heavy Model (CPA-CPAY)



MODEL	 NUMBER OF TINES (PIECES)	 CLEARANCE (CM)	 DISTANCE BETWEEN BEAMS (CM)	 WORKING WIDTH (CM)	 WORKING DEPTH (CM)	 WEIGHT (KG)	 POWER REQUIREMENT (HP)
CPH 05	5	50	25	125	30	262	30-35
CPH 07	7	50	25	175	30	327	35-45
CPH 09	9	50	25	225	30	393	45-60
CPH 11	11	50	25	275	30	509	60-70
CP 05	5	62	30	150	45	349	50-60
CP 07	7	62	30	210	45	421	60-80
CP 09	9	62	30	270	45	506	80-90
CP 11	11	62	30	330	45	720	90-100
CP 13	13	62	30	390	45	810	100-110
CP 15	15	62	30	450	45	900	120-140
CPA 05	5	62	30	150	45	410	60-70
CPA 07	7	62	30	210	45	513	70-90
CPA 09	9	62	30	270	45	660	90-100
CPA 11	11	62	30	330	45	823	100-110
CPA 13	13	62	30	390	45	930	110-120
CPA 15	15	62	30	450	45	1050	120-150
CPY 05	5	74	30	150	60	568	50-60
CPY 07	7	74	30	210	60	765	60-80
CPY 09	9	74	30	270	60	950	80-90
CPY 11	11	74	30	330	60	1250	90-100
CPY 13	13	74	30	390	60	1410	100-110
CPY 15	15	74	30	450	60	1730	120-140
CPAY 05	5	74	30	150	60	575	70-80
CPAY 07	7	74	30	210	60	735	80-90
CPAY 09	9	74	30	270	60	880	90-110
CPAY 11	11	74	30	330	60	1071	110-130
CPAY 13	13	74	30	390	60	1260	130-150
CPAY 15	15	74	30	450	60	1430	150-170

- It is possible to change the technical details above in line with customer needs.
- There may be changes in product technical details and standard accessories, product images are for general promotion.
- The specified required horsepowers may differ up to $\pm 20\%$ depending on the soil structure and technical characteristics of the tractors (two-wheel drive, etc.).
- The specified weights may differ up to $\pm 15\%$ depending on optional parts.

SUBSOILER (V FRAME)

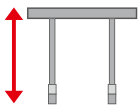
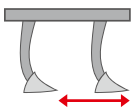
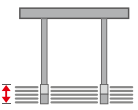

► Upon your specific needs, custom design multi position frame option with different tine spacing*.



MODEL	 NUMBER OF TINES (PIECES)	 CLEARANCE (CM)	 DISTANCE BETWEEN BEAMS (CM)	 WORKING DEPTH (CM)	 WEIGHT (KG)	 POWER REQUIREMENT (HP)
DKV 03	3	63-85	45*	55-75	565	110-120
DKV 05	5	63-85	45*	55-75	900	180-200

- It is possible to change the technical details above in line with customer needs.
- There may be changes in product technical details and standard accessories, product images are for general promotion.
- The specified required horsepowers may differ up to $\pm 20\%$ depending on the soil structure and technical characteristics of the tractors (two-wheel drive, etc.).
- The specified weights may differ up to $\pm 15\%$ depending on optional parts.

SUBSOILER

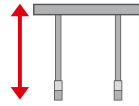
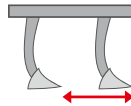
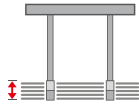

- ▶ High share savings thanks to shares made of heat-treated special materials.
- ▶ Possibility to create drainage pipes in the soil thanks to the 10 cm diameter expander attached to the back of the point.
- ▶ Perfect adaptation to every tractor with the clearance adjustment mechanism on the legs.
- ▶ Ability to work at 85 or 95 cm working depth with models of 73-95 cm or 73-105 cm clearance as an option.



MODEL	 NUMBER OF TINES (PIECES)	 CLEARANCE (CM)	 DISTANCE BETWEEN BEAMS (CM)	 WORKING DEPTH (CM)	 WEIGHT (KG)	 POWER REQUIREMENT (HP)
DK 01	1	63-85	—	55-75	205	70-80
DK 02	2	63-85	80-160	55-75	480	90-100
DK 03	3	63-85	40-60-80	55-75	575	110-120
DK 04	4	63-85	40	55-75	677	150-160
DK 05	5	63-85	20	55-75	926	180-200

- It is possible to change the technical details above in line with customer needs.
- There may be changes in product technical details and standard accessories, product images are for general promotion.
- The specified required horsepowers may differ up to $\pm 20\%$ depending on the soil structure and technical characteristics of the tractors (two-wheel drive, etc.).
- The specified weights may differ up to $\pm 15\%$ depending on optional parts.

CHISEL PLOUGH WITH SPRING

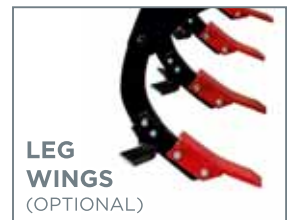
- ▶ Special alloyed cast steel legs designed to give the most suitable penetration angle for maximum efficiency.
- ▶ Possibility to work in different working widths thanks to adjustable leg spaces.
- ▶ Provides a vibrating and safe working opportunity with special production springs.
- ▶ Each independent spring leg, when it encounters an obstacle, stone, root, etc. only that leg is disabled, which provides an uninterrupted and safe working opportunity.

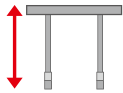
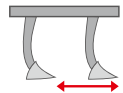
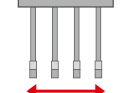
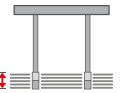



MODEL	 NUMBER OF TINES (PIECES)	 CLEARANCE (CM)	 DISTANCE BETWEEN BEAMS (CM)	 WORKING WIDTH (CM)	 WORKING DEPTH (CM)	 WEIGHT (KG)	 POWER REQUIREMENT (HP)
YCP 05	5	72,5	100	150	45	610	70-90
YCP 07	7	72,5	100	215	45	765	90-110
YCP 09	9	72,5	100	280	45	950	110-130
YCP 11	11	72,5	100	325	45	1100	130-150
YCP 13	13	72,5	100	390	45	1350	150-170
YCP 15	15	72,5	100	460	45	1535	170-200

- It is possible to change the technical details above in line with customer needs.
- There may be changes in product technical details and standard accessories, product images are for general promotion.
- The specified required horsepowers may differ up to $\pm 20\%$ depending on the soil structure and technical characteristics of the tractors (two-wheel drive, etc.).
- The specified weights may differ up to $\pm 15\%$ depending on optional parts.

SPRING TINE CULTIVATOR

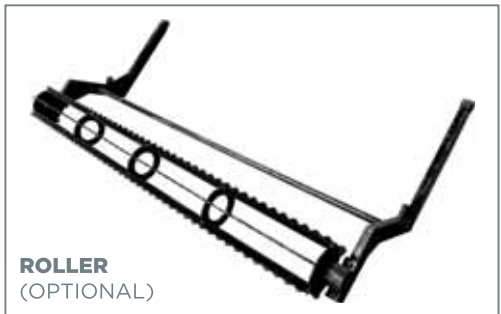
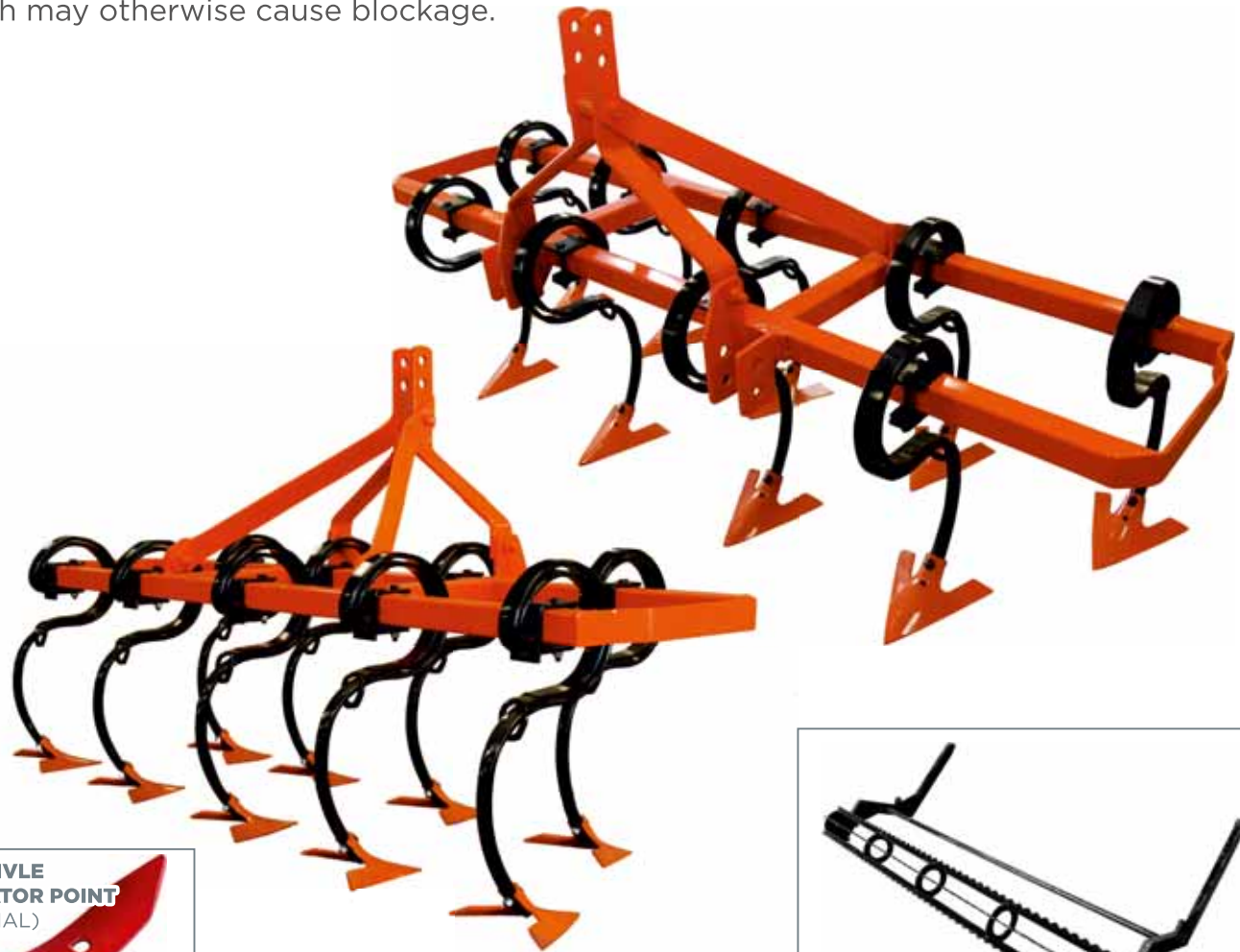
- ▶ Special alloy imported legs with additional support.
- ▶ Different share options suitable for different needs.
- ▶ Due to the vibrations, reduction of traction force.
- ▶ Good clearance for trashy conditions where the quantity of trash may otherwise cause blockage.

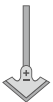
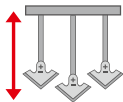
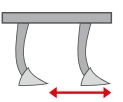
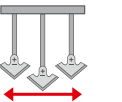
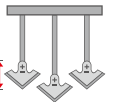

MODELO	 NUMBER OF TINES (PIECES)	 CLEARANCE (CM)	 DISTANCE BETWEEN BEAMS (CM)	 WORKING WIDTH (CM)	 WORKING DEPTH (CM)	 WEIGHT (KG)	 POWER REQUIREMENT (HP)
SKL07	7	53	25	150	10	156	30-40
SKL09	9	53	25	200	10	183	40-50
SKL11	11	53	25	250	10	211	50-60
SKL13	13	53	25	300	10	235	60-70
SKL15	15	53	25	350	10	276	70-80

- It is possible to change the technical details above in line with customer needs.
- There may be changes in product technical details and standard accessories, product images are for general promotion.
- The specified required horsepowers may differ up to ± 20% depending on the soil structure and technical characteristics of the tractors (two-wheel drive, etc.).
- The specified weights may differ up to ± 15% depending on optional parts.

SPRING CULTIVATOR (HEAVY MODEL)



- ▶ Different share options suitable for different needs.
- ▶ Greasable special bushing system on the legs.
- ▶ Due to the vibrations, reduction of traction force.
- ▶ Good clearance for trashy conditions where the quantity of trash may otherwise cause blockage.



CULTIVATOR POINT
(OPTIONAL)

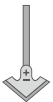
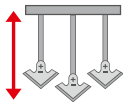
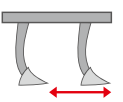
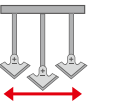
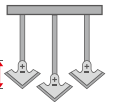

ROLLER
(OPTIONAL)

MODEL	 NUMBER OF TINES (PIECES)	 CLEARANCE (CM)	 DISTANCE BETWEEN BEAMS (CM)	 WORKING WIDTH (CM)	 WORKING DEPTH (CM)	 WEIGHT (KG)	 POWER REQUIREMENT (HP)
AKL05	5	62	25	125	15	294	40-50
AKL07	7	62	25	175	15	400	50-60
AKL09	9	62	25	225	15	481	60-70
AKL11	11	62	25	275	15	585	70-80
AKL13	13	62	25	325	15	727	80-100
AKL15	15	62	25	375	15	800	100-120

- It is possible to change the technical details above in line with customer needs.
- There may be changes in product technical details and standard accessories, product images are for general promotion.
- The specified required horsepowers may differ up to $\pm 20\%$ depending on the soil structure and technical characteristics of the tractors (two-wheel drive, etc.).
- The specified weights may differ up to $\pm 15\%$ depending on optional parts.

SPRING CULTIVATOR (LIGHT MODEL)

- ▶ Different share options suitable for different needs.
- ▶ Greasable and cemented special bushing system.
- ▶ Vibrating and safe working opportunity thanks to the springs.
- ▶ Due to the vibrations, reduction of traction force.
- ▶ Easy approach to tree roots and fence edges thanks to the hydraulic shifting mechanism (optional).

OPTIONAL PARTS

- ▶ Reversible cultivator point
- ▶ Hydraulic shifting mechanism
- ▶ Roller

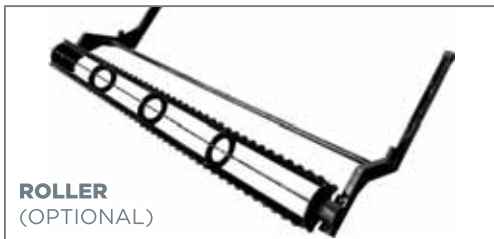



ROLLER
(OPTIONAL)



REVERSIBLE
CULTIVATOR POINT
(OPTIONAL)

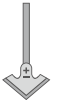
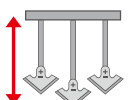
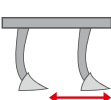
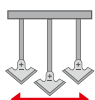
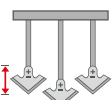

HYDRAULIC
SHIFTING MECHANISM
(OPTIONAL)









MODEL	 NUMBER OF TINES (PIECES)	 CLEARANCE (CM)	 DISTANCE BETWEEN BEAMS (CM)	 WORKING WIDTH (CM)	 WORKING DEPTH (CM)	 WEIGHT (KG)	 POWER REQUIREMENT (HP)
MKL05	5	45	25	125	10	157	30-35
MKL07	7	45	25	175	10	247	40-45
MKL09	9	45	25	225	10	324	45-50
MKL11	11	45	25	275	10	430	50-60
MKL13	13	45	25	325	10	487	60-80

- It is possible to change the technical details above in line with customer needs.
- There may be changes in product technical details and standard accessories, product images are for general promotion.
- The specified required horsepowers may differ up to $\pm 20\%$ depending on the soil structure and technical characteristics of the tractors (two-wheel drive, etc.).
- The specified weights may differ up to $\pm 15\%$ depending on optional parts.

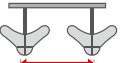
RIDGER PLOUGH

- ▶ Opportunity to open several furrows in one pass.
- ▶ Adjustable furrow width and dike height.
- ▶ Your new assistant for irrigation systems.
- ▶ Possibility to install swinging depth & transport wheel (optional).



MODELO	 NUMBER OF FURROWS (PIECES)	 CLEARANCE (CM)	 DISTANCE BETWEEN BEAMS (CM)	 DITCH BOTTOM WIDTH (CM)	 DITCH WIDTH (CM)	 DITCH DEPTH (CM)	 WEIGHT (KG)	 POWER REQUIREMENT (HP)
RP03 (ANGLE CHASSIS)	3	60	60-95 (at 5 cm intervals)	25	34-40-46	20-35	224	40-55
RP04 (ANGLE CHASSIS)	4	60	60-95 (at 5 cm intervals)	25	34-40-46	30-35	285	55-65
RPA03 (SQUARE TUBE CHASSIS)	3	65	70-90	25	34-40-46	20-35	262	50-60
RPA04 (SQUARE TUBE CHASSIS)	4	65	70-90	25	34-40-46	20-35	363	60-80
RPA05 (SQUARE TUBE CHASSIS)	5	65	70-90	25	34-40-46	20-35	450	80-90

- It is possible to change the technical details above in line with customer needs.
- There may be changes in product technical details and standard accessories, product images are for general promotion.
- The specified required horsepowers may differ up to $\pm 20\%$ depending on the soil structure and technical characteristics of the tractors (two-wheel drive, etc.).
- The specified weights may differ up to $\pm 15\%$ depending on optional parts.

DISC PLOUGH

- ▶ 20-30 % less fuel consumption compared to mouldboard ploughs.
- ▶ Standard or 660 mm, 710 mm diameter imported discs made of boron steel option.
- ▶ Excellent solution for highly abrasive, rooted or cohesive soil conditions.
- ▶ Adjustable disc penetration angle (5 level) to adapt to hard or loose soil structure.
- ▶ Adjustment arm for best tractor-plough adaptation.







MODEL	NUMBER OF DISCS (PIECES)	DISC DIAMETER (MM)	CLEARANCE (CM)	WORKING WIDTH (CM)	WORKING DEPTH (CM)	WEIGHT (KG)	POWER REQUIREMENT (HP)
DIP02	2	660	82	50-60-70	26	364	40-50
DIP03	3	660	82	70-75-100	26	469	50-60
DIP04	4	660	82	90-110-130	26	589	60-80
DIP05	5	660	82	110-135-160	26	664	80-90
DIPB03	3	660	68	75	26	423	50-60
DIPB04	4	660	68	100	26	555	60-80

- It is possible to change the technical details above in line with customer needs.
- There may be changes in product technical details and standard accessories, product images are for general promotion.
- The specified required horsepowers may differ up to $\pm 20\%$ depending on the soil structure and technical characteristics of the tractors (two-wheel drive, etc.).
- The specified weights may differ up to $\pm 15\%$ depending on optional parts.

MOUNTED & TRAILED V TYPE DISC HARROW (LIGHT MODEL)

- ▶ High resistible, heat treated discs notched at front and plain at rear or alternated.
- ▶ Easy working angle adjustment adjustable mechanically (standard) or hydraulically (optional).
- ▶ Increased inter-disc spacing and disc scrapers preventing trash built up.
- ▶ Additional weight bullets for heavy and stony soil conditions (optional).
- ▶ Bearing housings and spacers made from special alloyed steel for trouble-free and long-lasting operation.

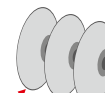
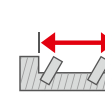
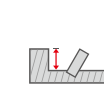



MODEL	 NUMBER OF DISCS (PIECES)	 DISC DIAMETER (MM)	 DISTANCE BETWEEN DISCS (CM)	 WORKING WIDTH (CM)	 WORKING DEPTH (CM)	 WEIGHT (KG)	 POWER REQUIREMENT (HP)
HDHV20-460	20	460	19	190	13	625	45-50
HDHV22-460	22	460	19	209	13	735	50-60
HDHV24-460	24	460	19	228	13	780	55-65
HDHV26-460	26	460	19	247	13	800	60-70
HDHV28-460	28	460	19	266	13	830	65-75
HDHV30-460	30	460	19	285	13	900	70-80
HDHV32-460	32	460	19	304	13	950	80-90
HDHV20-510	20	510	19	190	15	650	50-60
HDHV22-510	22	510	19	209	15	760	55-65
HDHV24-510	24	510	19	228	15	805	60-70
HDHV26-510	26	510	19	247	15	830	65-75
HDHV28-510	28	510	19	266	15	860	70-80
HDHV30-510	30	510	19	285	15	930	80-90
HDHV32-510	32	510	19	304	15	980	90-100

*SHAFT DIAMETER: 30x30 MM

- It is possible to change the technical details above in line with customer needs.
- There may be changes in product technical details and standard accessories, product images are for general promotion.
- The specified required horsepowers may differ up to $\pm 20\%$ depending on the soil structure and technical characteristics of the tractors (two-wheel drive, etc.).
- The specified weights may differ up to $\pm 15\%$ depending on optional parts.

MOUNTED & TRAILED V TYPE DISC HARROW

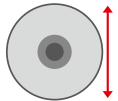
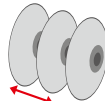
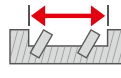
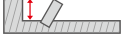

MODEL	 NUMBER OF DISCS (PIECES)	 DISC DIAMETER (MM)	 DISTANCE BETWEEN DISCS (CM)	 WORKING WIDTH (CM)	 WORKING DEPTH (CM)	 WEIGHT (KG)	 POWER REQUIREMENT (HP)
DHV16-560	16	560	23	184	17	945	45-55
DHV18-560	18	560	23	207	17	1000	55-65
DHV20-560	20	560	23	230	17	1100	65-75
DHV22-560	22	560	23	253	17	1230	75-85
DHV24-560	24	560	23	276	17	1300	85-95
DHV26-560	26	560	23	299	17	1385	95-105
DHV28-560	28	560	23	322	17	1400	105-115
DHV30-560	30	560	23	345	17	1420	115-125
DHV32-560	32	560	23	368	17	1490	125-135
DHV16-610	16	610	23	184	20	965	50-60
DHV18-610	18	610	23	207	20	1020	60-70
DHV20-610	20	610	23	230	20	1120	70-80
DHV22-610	22	610	23	253	20	1250	80-90
DHV24-610	24	610	23	276	20	1330	90-100
DHV26-610	26	610	23	299	20	1415	100-110
DHV28-610	28	610	23	322	20	1430	110-120
DHV30-610	30	610	23	345	20	1450	120-130
DHV32-610	32	610	23	368	20	1525	130-140

***SHAFT DIAMETER: 40x40 MM**

- It is possible to change the technical details above in line with customer needs.
- There may be changes in product technical details and standard accessories, product images are for general promotion.
- The specified required horsepowers may differ up to $\pm 20\%$ depending on the soil structure and technical characteristics of the tractors (two-wheel drive, etc.).
- The specified weights may differ up to $\pm 15\%$ depending on optional parts.

V TYPE DISC HARROW

- ▶ High resistible, heat treated discs notched at front and plain at rear or alternated.
- ▶ Increased inter-disc spacing and disc scrapers preventing trash built up.
- ▶ Bearing housings and spacers made from special alloyed steel for trouble-free and long-lasting operation.







MODEL	NUMBER OF DISCS (PIECES)	DISC DIAMETER (MM)	DISTANCE BETWEEN DISCS (CM)	WORKING WIDTH (CM)	WORKING DEPTH (CM)	WEIGHT (KG)	POWER REQUIREMENT (HP)
DHAV20	20	610	23	225	20	1170	70-80
DHAV22	22	610	23	250	20	1250	80-90
DHAV24	24	610	23	275	20	1320	90-100
DHAV26	26	610	23	300	20	1389	110-120
DHAV28	28	610	23	325	20	1460	120-130

- It is possible to change the technical details above in line with customer needs.
- There may be changes in product technical details and standard accessories, product images are for general promotion.
- The specified required horsepowers may differ up to $\pm 20\%$ depending on the soil structure and technical characteristics of the tractors (two-wheel drive, etc.).
- The specified weights may differ up to $\pm 15\%$ depending on optional parts.

TRAILED V TYPE DISC HARROW

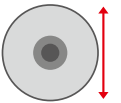
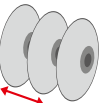
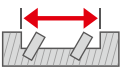
- ▶ Easy working angle adjustment adjustable mechanically (standard) or hydraulically (optional).
- ▶ Increased inter-disc spacing and disc scrapers preventing trash built up.
- ▶ Bearing housings and spacers made from special alloyed steel for trouble-free and long-lasting operation.







MODELO	 NUMBER OF DISCS (PIECES)	 DISC DIAMETER (MM)	 DISTANCE BETWEEN DISCS (CM)	 WORKING WIDTH (CM)	 WORKING DEPTH (CM)	 WEIGHT (KG)	 POWER REQUIREMENT (HP)
CDHVH20	20	560	23	230	15	670	60-65
CDHVH22	22	560	23	253	15	760	65-75
CDHVH24	24	560	23	276	15	820	70-80

- It is possible to change the technical details above in line with customer needs.
- There may be changes in product technical details and standard accessories, product images are for general promotion.
- The specified required horsepowers may differ up to $\pm 20\%$ depending on the soil structure and technical characteristics of the tractors (two-wheel drive, etc.).
- The specified weights may differ up to $\pm 15\%$ depending on optional parts.

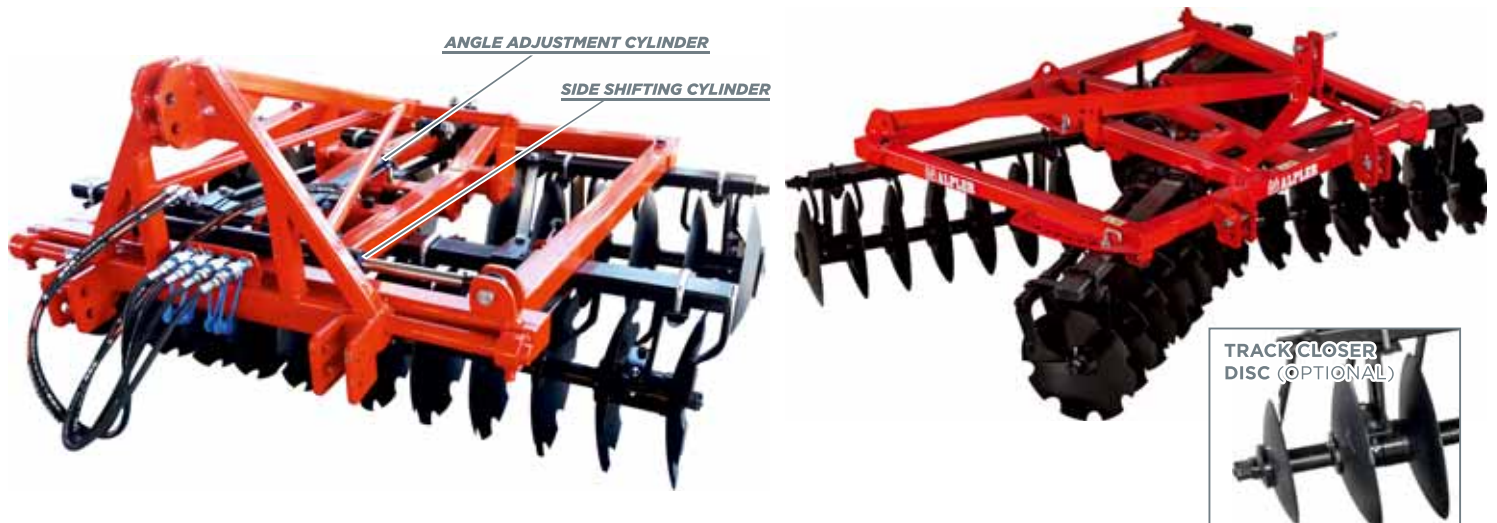
MOUNTED X TYPE DISC HARROW

- ▶ Manual or Hydraulic (optional) mechanism for shifting the disc harrow (Left/Right) easily closer to the trees and fences.
- ▶ Easy gang angling adjustment with locking pins (Standard) or Hydraulically (Optional).
- ▶ Equipped with S tine in the middle to prevent dikes formation.
- ▶ Steel Spacers and bearing housings for trouble free long working life.
- ▶ High resistible, heat treated discs notched at front and plain at rear or alternated.

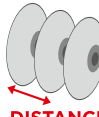
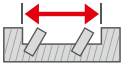
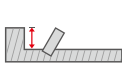



MODEL	 NUMBER OF DISCS (PIECES)	 DISC DIAMETER (MM)	 DISTANCE BETWEEN DISCS (CM)	 WORKING WIDTH (CM)	 WORKING DEPTH (CM)	 WEIGHT (KG)	 POWER REQUIREMENT (HP)
AXD20-460	20	460	19	190	10	620	45-55
AXD24-460	24	460	19	228	10	685	55-65
AXD28-460	28	460	19	266	10	785	65-75
AXD32-460	32	460	19	304	10	820	75-85
AXD36-460	36	460	19	342	10	840	85-100
AXD20-510	20	510	19	190	15	645	50-60
AXD24-510	24	510	19	228	15	710	60-70
AXD28-510	28	510	19	266	15	830	70-80
AXD32-510	32	510	19	304	15	893	80-100
AXD36-510	36	510	19	342	15	960	100-120
AXD20-560	20	560	19	190	17	670	50-60
AXD24-560	24	560	19	228	17	735	60-70
AXD28-560	28	560	19	266	17	855	70-80
AXD32-560	32	560	19	304	17	920	80-100
AXD36-560	36	560	19	342	17	1020	100-120

*SHAFT DIAMETER: 30x30 MM *Optional 23 cm distance between discs

TRAILED V TYPE HEAVY DISC HARROW

- ▶ High resistible, heat treated discs notched at front and plain at rear or alternated.
- ▶ Transport tyres also ensure optimum working depth control.
- ▶ Ease and speed of set-up into the work/transport position.
- ▶ Increased inter-disc spacing and disc scrapers preventing trash built up.
- ▶ Spacers and bearing housings made from steel for trouble free long working life.

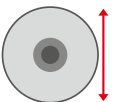
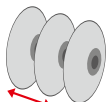
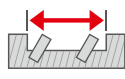
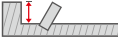





MODEL	 NUMBER OF DISCS (PIECES)	 DISC DIAMETER (MM)	 DISTANCE BETWEEN DISCS (CM)	 WORKING WIDTH (CM)	 WORKING DEPTH (CM)	 WEIGHT (KG)	 POWER REQUIREMENT (HP)
CDHV16-610	16	610	23	184	20	1620	60-70
CDHV18-610	18	610	23	207	20	1780	70-80
CDHV20-610	20	610	23	230	20	2000	80-90
CDHV22-610	22	610	23	253	20	2040	90-100
CDHV24-610	24	610	23	276	20	2340	100-110
CDHV26-610	26	610	23	299	20	2400	110-120
CDHV28-610	28	610	23	322	20	2460	120-130
CDHV30-610	30	610	23	345	20	2520	130-140
CDHV16-660	16	660	23	184	25	1650	70-80
CDHV18-660	18	660	23	207	25	1810	80-90
CDHV20-660	20	660	23	230	25	2030	90-100
CDHV22-660	22	660	23	253	25	2070	100-110
CDHV24-660	24	660	23	276	25	2380	110-120
CDHV26-660	26	660	23	299	25	2440	120-130
CDHV28-660	28	660	23	322	25	2500	130-140
CDHV30-660	30	660	23	345	25	2560	140-150

*SHAFT DIAMETER: 40x40 MM

TRAILED V TYPE HEAVY DISC HARROW (FOLDING)

- ▶ High resistible, heat treated discs notched at front and plain at rear or alternated.
- ▶ Transport tyres also ensure optimum working depth control.
- ▶ Ease and speed of set-up into the work/transport position.
- ▶ Increased inter-disc spacing and disc scrapers preventing trash built up.
- ▶ Spacers and bearing housings made from steel for trouble free long working life.

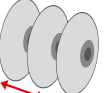
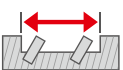
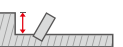

MODEL	 NUMBER OF DISCS (PIECES)	 DISC DIAMETER (MM)	 DISTANCE BETWEEN DISCS (CM)	 WORKING WIDTH (CM)	 WORKING DEPTH (CM)	 WEIGHT (KG)	 POWER REQUIREMENT (HP)
CDHV 32-610	32	610	23	368	20	3000	140-150
CDHV 34-610	34	610	23	391	20	3250	150-160
CDHV 36-610	36	610	23	414	20	3360	160-170
CDHV 38-610	38	610	23	437	20	3430	170-180
CDHV 40-610	40	610	23	460	20	3500	180-200
CDHV 44-610	44	610	23	506	20	3640	200-220
CDHV 48-610	48	610	23	552	20	3780	220-240
CDHV 32-660	32	660	23	368	25	3050	150-160
CDHV 34-660	34	660	23	391	25	3300	160-170
CDHV 36-660	36	660	23	414	25	3410	170-180
CDHV 38-660	38	660	23	437	25	3480	180-200
CDHV 40-660	40	660	23	460	25	3560	200-220
CDHV 44-660	44	660	23	506	25	3700	220-240
CDHV 48-660	48	660	23	552	25	3840	230-250



*SHAFT DIAMETER: 40x40 MM

- It is possible to change the technical details above in line with customer needs.
- There may be changes in product technical details and standard accessories, product images are for general promotion.
- The specified required horsepowers may differ up to $\pm 20\%$ depending on the soil structure and technical characteristics of the tractors (two-wheel drive, etc.).
- The specified weights may differ up to $\pm 15\%$ depending on optional parts.

TRAILED X TYPE HEAVY DISC HARROW

- ▶ High resistible, heat treated discs notched at front and plain at rear or alternated.
- ▶ Transport tyres also ensure optimum working depth control.
- ▶ Ease and speed of set-up into the work/transport position.
- ▶ Increased inter-disc spacing and disc scrapers preventing trash built up.
- ▶ Spacers and bearing housings made from steel for trouble free long working life.

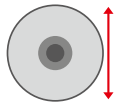
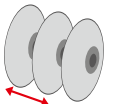
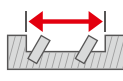
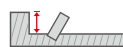





MODEL	 NUMBER OF DISCS (PIECES)	 DISC DIAMETER (MM)	 DISTANCE BETWEEN DISCS (CM)	 WORKING WIDTH (CM)	 WORKING DEPTH (CM)	 WEIGHT (KG)	 POWER REQUIREMENT (HP)
CDHX20	20	610	23	250	22	1660	80-90
CDHX24	24	610	23	300	22	1920	100-110
CDHX28	28	610	23	350	22	2120	120-130

- It is possible to change the technical details above in line with customer needs.
- There may be changes in product technical details and standard accessories, product images are for general promotion.
- The specified required horsepowers may differ up to $\pm 20\%$ depending on the soil structure and technical characteristics of the tractors (two-wheel drive, etc.).
- The specified weights may differ up to $\pm 15\%$ depending on optional parts.

COMPACT DISC HARROW (MOUNTED)

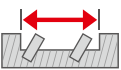
- ▶ Special alloyed, long-lasting, notched discs.
- ▶ Possibility to work without risk with increased inter-disc spacing.
- ▶ Grease-free and maintenance-free durable bearing houses.
- ▶ Possibility to work smoothly on stony terrains thanks to the rubber elements in the disc connection system.

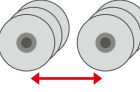
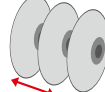



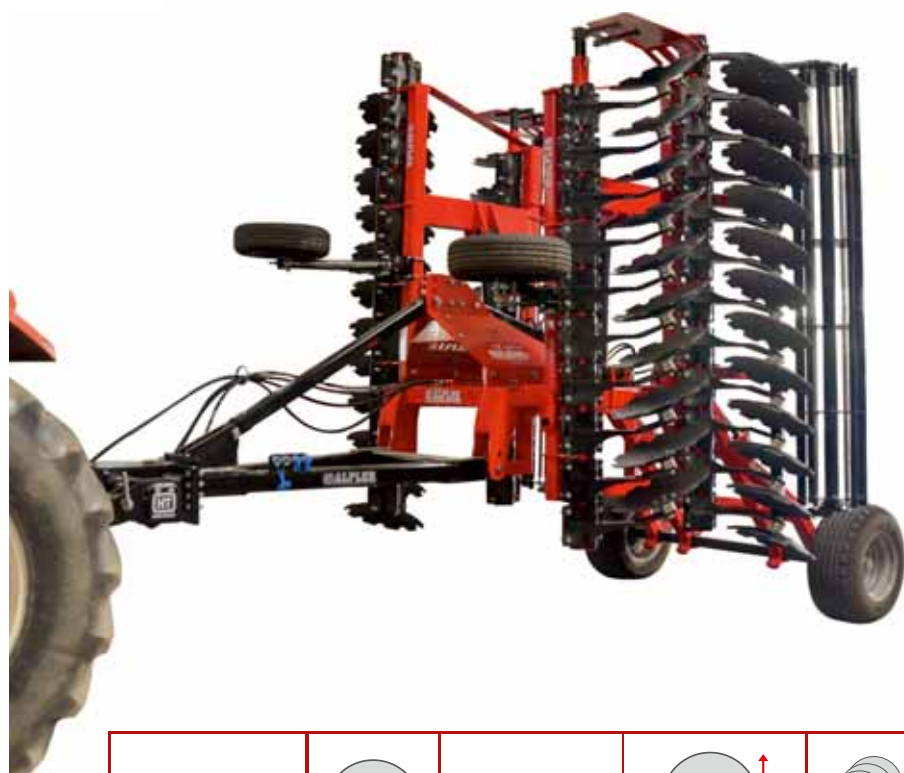

MODEL	 NUMBER OF DISCS (PIECES)	 WORKING WIDTH (CM)	 DISC DIAMETER (MM)	 DISTANCE BETWEEN BEAMS (CM)	 DISTANCE BETWEEN DISCS (CM)	 WEIGHT (KG)	 POWER REQUIREMENT (HP)
BDH 18-560	18	225	560	100	25	1310	70-80
BDH 20-560	20	250	560	100	25	1415	80-90
BDH 22-560	22	275	560	100	25	1520	90-100
BDH 24-560	24	300	560	100	25	1640	100-120
BDH 26-560	26	325	560	100	25	1760	120-140
BDH 28-560	28	350	560	100	25	1890	140-180
BDH 30-560	30	375	560	100	25	2070	160-180
BDH 32-560	32	400	560	100	25	2240	180-200

- It is possible to change the technical details above in line with customer needs.
- There may be changes in product technical details and standard accessories, product images are for general promotion.
- The specified required horsepowers may differ up to $\pm 20\%$ depending on the soil structure and technical characteristics of the tractors (two-wheel drive, etc.).
- The specified weights may differ up to $\pm 15\%$ depending on optional parts.

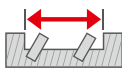
COMPACT DISC HARROW (TRAILED)

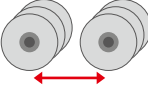
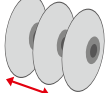



MODEL	 NUMBER OF DISCS (PIECES)	 WORKING WIDTH (CM)	 DISC DIAMETER (MM)	 DISTANCE BETWEEN BEAMS (CM)	 DISTANCE BETWEEN DISCS (CM)	 WEIGHT (KG)	 POWER REQUIREMENT (HP)
BDH 32-560	32	400	560	100	25	3840	180-220
BDH 36-560	36	450	560	100	25	4050	200-240
BDH 40-560	40	500	560	100	25	4260	240-280
BDH 44-560	44	550	560	100	25	4470	260-300
BDH 48-560	48	600	560	100	25	4680	300-340

- It is possible to change the technical details above in line with customer needs.
- There may be changes in product technical details and standard accessories, product images are for general promotion.
- The specified required horsepowers may differ up to $\pm 20\%$ depending on the soil structure and technical characteristics of the tractors (two-wheel drive, etc.).
- The specified weights may differ up to $\pm 15\%$ depending on optional parts.

TRAILED X TYPE DISC HARROW

- ▶ High resistible, heat treated discs notched at front and plain at rear or alternated.
- ▶ Transport tyres also ensure optimum working depth control.
- ▶ Ease and speed of set-up into the work/transport position.
- ▶ Increased inter-disc spacing and disc scrapers preventing trash built up.
- ▶ Spacers and bearing housings made from steel for trouble free long working life.

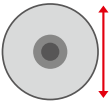
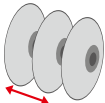
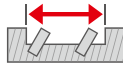
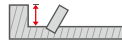

MODEL	 NUMBER OF DISCS (PIECES)	 DISC DIAMETER (MM)	 DISTANCE BETWEEN DISCS (CM)	 WORKING WIDTH (CM)	 WORKING DEPTH (CM)	 WEIGHT (KG)	 POWER REQUIREMENT (HP)
CDHLX20	20	510	19	190	10	920	40-60
CDHLX24	24	510	19	228	10	960	60-70
CDHLX28	28	510	19	266	10	1020	70-80
CDHLX32	32	510	19	304	10	1060	80-100
CDHLX36	36	510	19	342	10	1120	100-120

- It is possible to change the technical details above in line with customer needs.
- There may be changes in product technical details and standard accessories, product images are for general promotion.
- The specified required horsepowers may differ up to $\pm 20\%$ depending on the soil structure and technical characteristics of the tractors (two-wheel drive, etc.).
- The specified weights may differ up to $\pm 15\%$ depending on optional parts.

REAR BLADE (LIGHT MODEL)

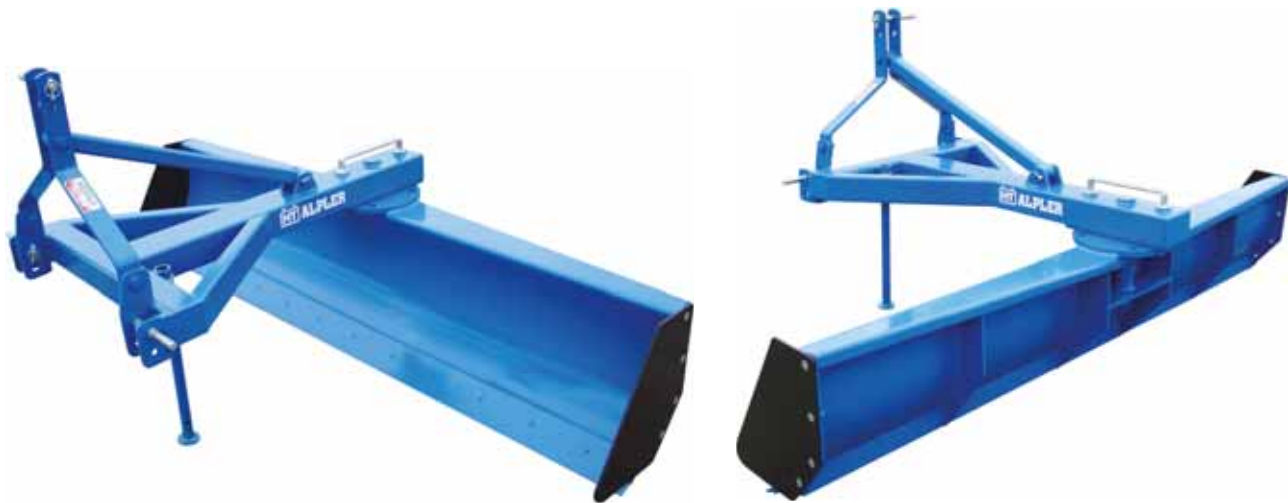

- ▶ Ideal for light road maintenance, lawn care, gardening and other light duty landscaping applications, leveling ground and snow and manure removal.
- ▶ TKL rear blades feature a reversible and replaceable heat treated 12 mm thickness cutting edge.
- ▶ Rear blades are CAT 2 (Standard) or CAT 1 (Optional) hitch compatible and the parking stand is standard equipment for ease of montage and safety.
- ▶ Bolted end plates allow holding extra material while dragging it from one place to another for filling.
- ▶ Effective due to the high, correctly shaped blade design 50 cm height with 6 mm thickness. It allows to cut and roll the soil rather than drag it, saving your time, HP and fuel.
- ▶ 360 degrees pivoting blade with 5 forward and 5 reverse angle positions, locking with 2 locking pins.

MODEL	WORKING WIDTH (CM)	WEIGHT (KG)	POWER REQUIREMENT (HP)
TKL100	100	165	15-25
TKL120	120	175	15-25
TKL140	140	200	15-25
TKL160	160	220	25-35
TKL180	180	230	25-35
TKL200	200	250	35-50
TKL220	220	266	40-50
TKL240	240	279	50-60
TKL250	250	275	50-60
TKL300	300	310	60-80

- It is possible to change the technical details above in line with customer needs.
- There may be changes in product technical details and standard accessories, product images are for general promotion.
- The specified required horsepowers may differ up to $\pm 20\%$ depending on the soil structure and technical characteristics of the tractors (two-wheel drive, etc.).
- The specified weights may differ up to $\pm 15\%$ depending on optional parts.

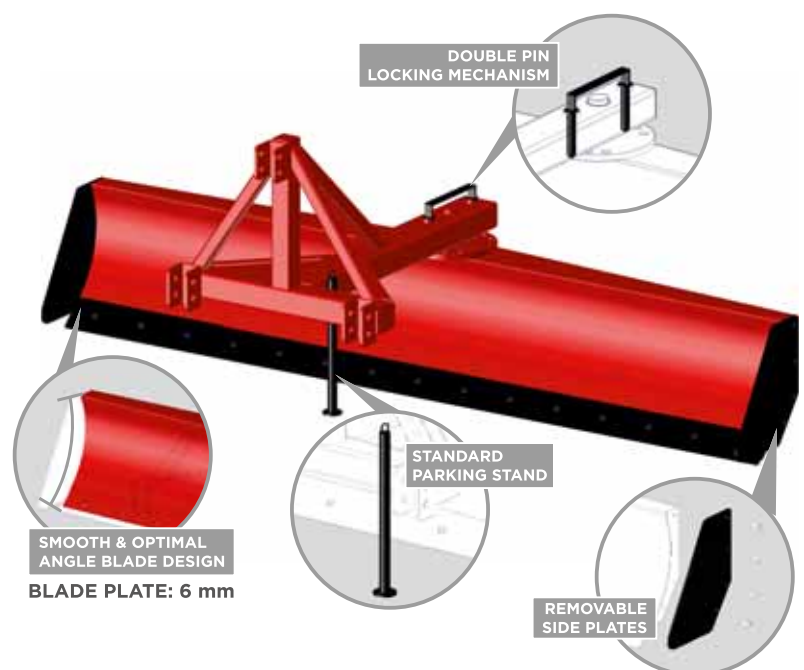

REAR BLADE

- ▶ Ideal for light road maintenance, lawn care, gardening and other light duty landscaping applications, leveling ground and snow and manure removal.
- ▶ TKH rear blades feature a reversible and replaceable heat treated 12 mm thickness cutting edge.
- ▶ Rear blades are CAT 2 hitch compatible and the parking stand is standard equipment for ease of montage and safety.
- ▶ Bolted end plates allow holding extra material while dragging it from one place to another for filling.
- ▶ Effective due to the high, correctly shaped blade design 60 cm height with 6 mm thickness. It allows to cut and roll the soil rather than drag it, saving your time, HP and fuel.
- ▶ Hydraulic stepless blade rotation adjustment over 290 degrees.

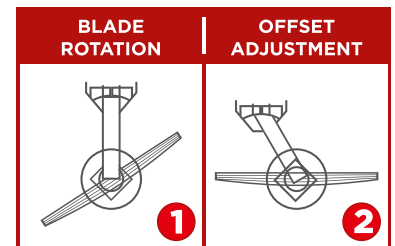

CHASSIS (MM): 150X100X6,3
BLADE PLATE: 6 mm





MODEL	WORKING WIDTH (CM)	BLADE HEIGHT (CM)	1 BLADE ROTATION	2 OFFSET ADJUSTMENT	KG WEIGHT (KG)	POWER REQUIREMENT (HP)
TK200	200	60	Manual	—	400	40-60
TK250	250	60	Manual	—	435	50-70
TK300	300	60	Manual	—	460	60-80
TKT200	200	60	Manual	—	480	40-60
TKT250	250	60	Manual	—	515	50-70
TKT300	300	60	Manual	—	540	60-80
TKH200	200	60	Hydraulic	Hydraulic	445	40-60
TKH250	250	60	Hydraulic	Hydraulic	480	50-70
TKH300	300	60	Hydraulic	Hydraulic	505	60-80
TKHT200	200	60	Hydraulic	Hydraulic	525	40-60
TKHT250	250	60	Hydraulic	Hydraulic	560	50-70
TKHT300	300	60	Hydraulic	Hydraulic	585	60-80

- It is possible to change the technical details above in line with customer needs.
- There may be changes in product technical details and standard accessories, product images are for general promotion.
- The specified required horsepowers may differ up to ± 20% depending on the soil structure and technical characteristics of the tractors (two-wheel drive, etc.).
- The specified weights may differ up to ± 15% depending on optional parts.

BOX LEVELER MACHINE

- ▶ Your economic partner for land leveling applications.
- ▶ Continuous, easy and fast loading and unloading possibilities by separate hydraulic adjustments.







MODEL	 WORKING WIDTH (M)	 BOX CAPACITY (M ³)	 TRANSPORT POSITION HEIGHT (CM)	 WEIGHT (KG)	 POWER REQUIREMENT (HP)
KTM3	255	3	25	2100	80-90
KTM4	255	4	25	2400	90-110

- It is possible to change the technical details above in line with customer needs.
- There may be changes in product technical details and standard accessories, product images are for general promotion.
- The specified required horsepowers may differ up to ± 20% depending on the soil structure and technical characteristics of the tractors (two-wheel drive, etc.).
- The specified weights may differ up to ± 15% depending on optional parts.

LASER CONTROLLED LEVELER MACHINE

- ▶ Zero, single or double slope working options.
- ▶ Box section top quality steel frame construction.
- ▶ Special heat treated steel double side share with unique design to get the most convenient penetration angle for maximum efficiency.
- ▶ Rugged design laser equipment are built to be strong and job-site tough! The mechanical / optical unit is mounted in sealed water proof aluminum housing (IP 67).
- ▶ The housing has an integrated handle for ease of handling.



MODEL	 TOTAL WIDTH IN TRANSPORT POSITION (M)	 WORKING WIDTH (M)	 TOTAL LENGTH (M)	 WEIGHT (KG)	 POWER REQUIREMENT (HP)
LTM 250 A*	2,5	2,5	5	1800	70-90
LTM 300 A*	3	3	5	1950	90-110
LTM 300	2,5	3	5	2350	90-110
LTM 350	2,5	3,5	5	2400	100-110
LTM 400	2,5	4	5	2450	110-120
LTM 450	3	4,5	5	2500	110-135
LTM 500	3	5	5	2550	135-160
LTM 550	3,5	5,5	5	2700	160-180
LTM 600	3,5	6	5,5	3500	180-200

* Fixed bucket (unfoldable)

- It is possible to change the technical details above in line with customer needs.

- There may be changes in product technical details and standard accessories, product images are for general promotion.

- The specified required horsepowers may differ up to $\pm 20\%$ depending on the soil structure and technical characteristics of the tractors (two-wheel drive, etc.).

- The specified weights may differ up to $\pm 15\%$ depending on optional parts.

LASER CONTROLLED LEVELER MACHINE

- ▶ Operating instructions booklet and movie (English).
- ▶ Light yet strong, easily installing tripod.
- ▶ All laser equipments are supplied in a sturdy carrying case. The case is compact so it can be stowed under or behind your seat; you do not have to worry about wear and tear as the laser is well protected by the case.



▶ **OPTIONAL MODEL**

▶ **WORK POSITION**



▶ **OPTIONAL MODEL**

▶ **TRANSPORT POSITION**

▶ **Topcon Laser Equipment**



OPTIONAL PARTS

SLATTED BODY (F - TYPE)



In clayey (sticky) and heavy soil conditions, it prevents the soil from sticking to the mouldboard surface by reducing the friction surface thanks to its fragmented structure and economizes on tractor traction force.

BAR POINT BODY



In very stony and hard soil conditions, the bar point provides economy and resistance of the point. Even if the bar point is worn, the first day ploughing quality continues in each ploughing thanks to its ease of being pushed forward.

DEFLECTOR



Provides better burying of harvest residues in the soil and prevents blocking.

DISC COULTER



Provides a clean furrow wall by cutting plant residues and soil layers.

TRASH BOARDS



Provides better burying of harvest residues in the soil and prevents blocking.

SKIMMER (UNIVERSAL)



It cuts off the top of the soil layer, fertilizer, plant material and harvest residues beforehand and throws it to the bottom of the previous furrow. In this way, the regrowth of deeply buried herbs is prevented. It also increases the soil productivity.

SHARES WITH REVERSIBLE POINTS



In case of wear of the share point, it can be replaced easily and effortlessly, saving the point and time.

SKIMMER (MAIZE)



It cuts off the top of the soil layer, fertilizer, plant material and harvest residues beforehand and throws it to the bottom of the previous furrow. In this way, the regrowth of deeply buried herbs is prevented. It also increases the soil productivity.

METAL DEPTH WHEEL



Working depth adjustment wheel suitable for any type of plough with low rolling resistance and low need of traction force due to its extended wheel diameter and special wheel form.

SHEAR BOLT SAFETY



The safety bolt in the chassis structure is cut in case of extreme stresses and the damages that may occur in tractor or plough is prevented by turning back from the body connection point. Due to this feature, it is recommended to use in newly planted or stony and rooted lands.

SWINGING DEPTH & TRANSPORT WHEEL



Easily adjustable, 12-ply, heavy-duty rubber wheel for transport and depth adjustment.

WING COULTER



Since the plough cuts the soil layers by leaning sideways, less blocking occurs. It also provides a clean furrow wall.

ROLLER



Working in combination with a chisel and cultivator, the roller is used for preparing a good seedbed as well as compacting the soil and breaking up the clods. Thanks to the roller, moisture loss in the crumbling soil is prevented.

CUSTOMIZED PRODUCTS



MULCH LAYING MACHINE



**UNDERGROUND DRIP IRRIGATION
PIPE INSTALLER MACHINE**



CULTIVATOR WITH S TINE



INTER ROW CULTIVATOR



DEEP VINEYARD PLOUGH



STUBBLE CULTIVATOR



BIG DITCHER



CAMBRIDGE ROLLER



HT ALPLER
 AGRICULTURAL MACHINERY

